

# APPLICATION NOTE

Fiber Optics & Photonics

# 12

Near Field Imaging of a Laser Diode  
Using Scanning Method



**Newport**<sup>®</sup>

Experience | Solutions

# Near Field Imaging of a Laser Diode Using Scanning Method

Jay Jeong, Ph.D., Sr. Photonics Packaging Engineer • Newport Corporation

## Introduction

This application note describes the result of an experiment performed on near field imaging of a laser diode emission pattern at the output facet. The purpose of the experiment was to provide a proof-of-concept system for the near field measurement of a high-power laser diode bar. The target resolution was approximately 1  $\mu\text{m}$ . The measurement setup was constructed on Newport AutoAlign8000 alignment system, which consists of two motion stage stacks and a stationary center post. Beam profiling was achieved by using a high magnification microscope objective and scanning a detector with a pinhole, as opposed to using a camera. Simple theoretical backgrounds to understand the near field imaging and measurement limitations are explained. The experiment was performed on a 980 nm laser diode output, using various optical systems. Based on the scanned profiles, the resolution limits of each optics was estimated.

## Backgrounds

The near field is usually defined as the optical field where the curvature of the optical field at the diffracting aperture cannot be assumed to be planar, where Fresnel diffraction formulation must be considered. For semiconductor lasers, mapping the field or intensity distribution at or near the output facet is one of important characterization tasks.

The basic concept of the near field profiling is to use a high magnification microscopic system to image the laser facet while the emission is generated. This experimental setup is easy to build, but it suffers from the diffraction limits set by the optical system, unlike other popular near field systems such as SNOMs (scanning near field optical microscopes). A typical diffraction limit of a microscope objective is on the order of 1  $\mu\text{m}$ .

No matter how good the optical system is, it is impossible to have an infinite resolution power, because of the phenomenon of diffraction. The image always forms the so-called Airy disk, which is the central bright spot of the diffraction pattern. Based on the Airy pattern, it is possible to determine the theoretical limit on the resolution of two adjacent points, and it is called the Rayleigh's criterion,

$$x_{\min} = f \left( \frac{1.22\lambda}{D} \right) = \frac{1.22\lambda}{NA}$$

where  $x_{\min}$  is the resolution limit,

$f$  is the focal length of the lens system,  
 $\lambda$  is the wavelength of the light,  
 $D$  is the aperture size of the lens, and  
 $NA$  is the numerical aperture.

The calculated resolution is to be 1.25  $\mu\text{m}$  at the wavelength of 0.98  $\mu\text{m}$  for a 100X microscope objective lens, which has NA of 0.95, 1.41  $\mu\text{m}$  for a 60X lens, and 2.99  $\mu\text{m}$  for a 20X lens. This limit is purely based on diffraction. Since any optical system has some kind of aberration built into it, the resolving power is always less than the theoretical limit. The point spread function (PSF) can give a better estimate about the resolution of a real optical system. It is the Fourier transform of a point through an optical system. The PSF of a perfect optical system without aberration would be an Airy pattern.

## Near Field Beam Profiler Setup

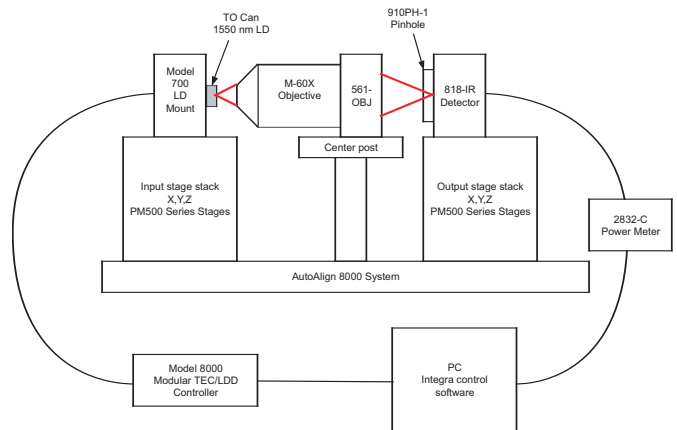

Figure 1. A schematic of the experimental setup.

Figure 1 is the schematic of the experimental setup. The system was built based on a Newport AutoAlign 8000 system. The system consists of two stacks of XYZ stages and a center post, installed on an optical isolation table. On the input stage stack, a 1550 nm laser diode in a TO can was mounted on Model 700 Temperature Controlled Mount. On the center post, microscope objective lenses with various magnifications were mounted. An 818-IR

detector, with a 1 μm pinhole glued on it, was mounted on the output stage stack. The laser diode was controlled by Model 8000 Modular controller, and the optical power was measured using a 2832-C power meter. The Integra process control software controlled the motion and collected measurement data.

Other light sources such as single mode fiber and multimode fiber were also tested. In such cases, instead of Model 700 Mount, other Newport fiber mounts were used, as shown in figures below. We also tested other lenses, such as an Olympus PMPlan 100X, a Newport M-20X objective, and a biconvex lens.

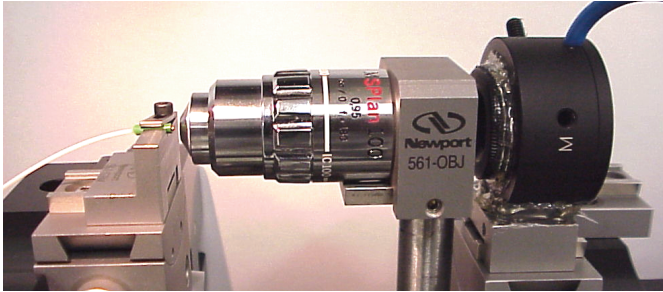

Figure 2. A near field beam profiling setup using a 100X microscope objective lens.

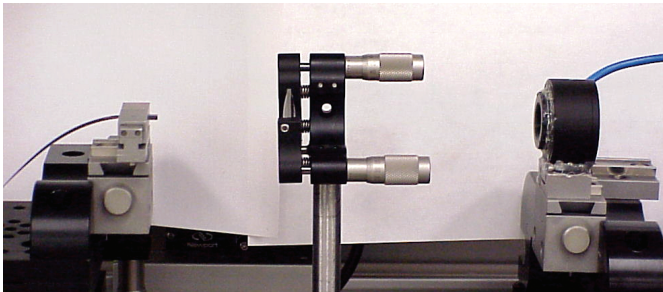

Figure 3. A near field beam profiling setup using a simple biconvex lens.

### Magnified vs. Nonmagnified Images

Since we have constructed a flexible optical system, we can perform the experiment with two different methods, first by moving the detector only, and second, by moving both the lens and the detector. The difference between the two can be easily understood with a simple ray tracing model.

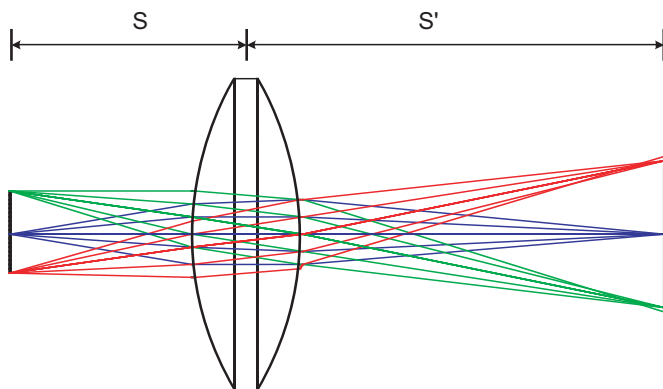

Figure 4. A ray tracing model of a simple biconvex lens.

Figure 4 shows the relationship between the object space and the image space and the degree of aberration at the image plane. When the detector only is moved, it will scan the magnified image.

$$\frac{1}{s} + \frac{1}{s'} = \frac{1}{f}, \quad m = -\frac{s'}{s}$$

where  $s$  is the distance from the source to the lens

$s'$  is the distance from the image to the lens  
 $f$  is the focal length of the lens, and  
 $m$  is the magnification factor.

The magnified image is achieved by moving the detector only, placed at a specified distance from the lens to achieve a desired magnification. This method may achieve a high magnification but also introduces the off-axis aberration. Therefore it is not a good method for measuring a large sized high power laser diode or diode bar.

The Unity magnification image is achieved by moving the source or moving the lens and the detector together. Only the portion of the object on the optical axis will reach the detector through the pinhole, free of the off-axis aberration. This approach is more advantageous when the near field measurement of a multimode, high power laser diode with large dimensions is required.

### Measurements Using Various Optical Systems

#### IR camera with a 100X objective lens (Reference image)

We first took the image of the test laser diode using a 100X objective lens and an IR camera. The optical principle is identical to the scanning system, with the only difference of grabbing the whole image instead of scanning line by line to construct the image. The spot size of the laser diode beam is determined to be roughly 2.0 μm in diameter. We measured it by comparing the movement of the spot with a specified step size compared to the size of the beam. There was no way of estimating the diameter accurately because the intensity profile was not obtainable and the neutral density filter was not calibrated. Nonetheless, we used this measurement as a reference for the scanning measurements, assuming the resolution of the 100X objective is better than 2 μm.

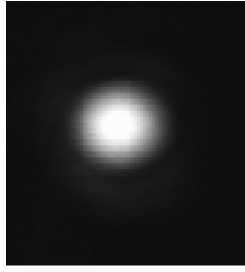

Figure 5. An image of a laser diode emission obtained using an IR camera with a 100X objective lens.

### Scanning with Various Lenses

The data were taken with the input stage stack scanned, saved in a text format, and exported to Matlab for an analysis. The  $e^1$  field point is determined to be 1.32  $\mu\text{m}$  and 1.29  $\mu\text{m}$  in the  $x$  and the  $y$  direction, respectively, fitting the data to a Gaussian profile. For a 60 X microscope objective, we obtained 1.64  $\mu\text{m}$  and 1.51  $\mu\text{m}$ , 2.06  $\mu\text{m}$  and 2.01  $\mu\text{m}$  for a 20X objective, and finally 8.27  $\mu\text{m}$  and 7.85  $\mu\text{m}$  for the biconvex lens.

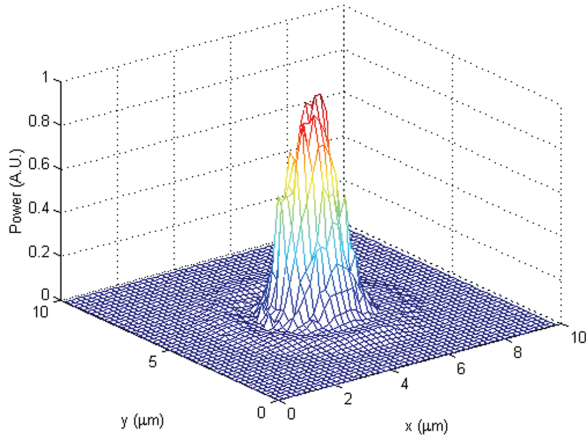

Figure 6. A 3D Profile data obtained for the laser diode using a 100X objective lens.

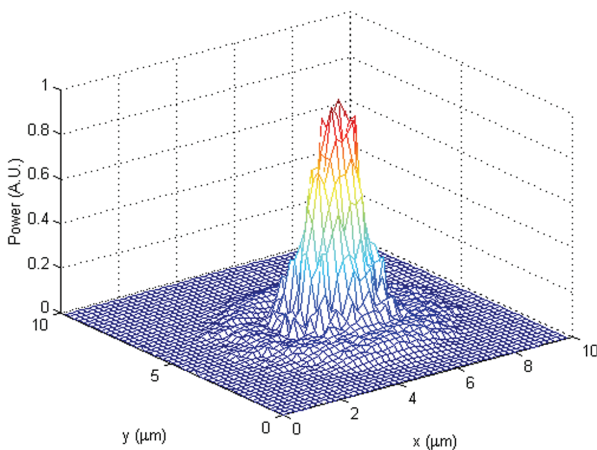

Figure 7. A 3D Profile data obtained for the laser diode using a 60X objective lens.

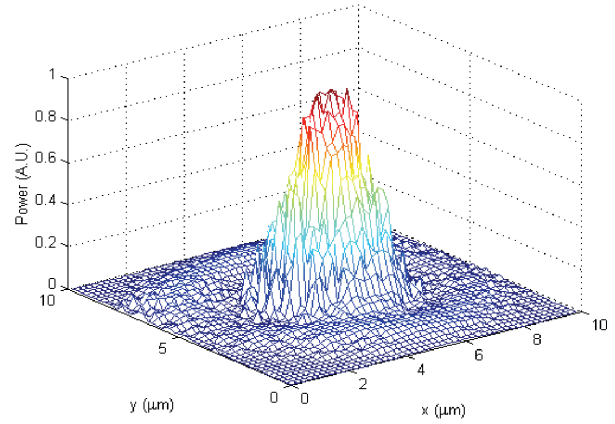

Figure 8. A 3D Profile data obtained for the laser diode using a 20X objective lens.

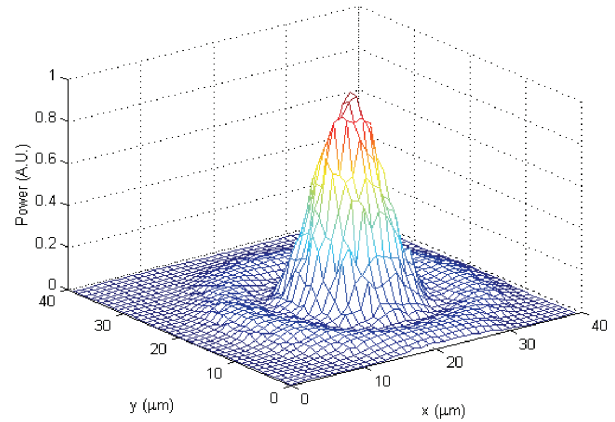

Figure 9. A 3D Profile data obtained for the laser diode using a simple biconvex lens.

### Conclusion

We constructed a near field scanning system based on a high magnification lens and a detector with a pinhole, built on Newport AutoAlign8000 system. With a 100X and a 60X objective lens, the spot sizes of a laser diode were comparable to the image observed with a high mag camera, with the resolution of close to 1  $\mu\text{m}$ , which is enough to resolve the fine structures in large size, high power semiconductor lasers.

Spot size decreased as the NA of the lens increases, in accordance with the prediction. For the same object, the 100X objective lens can focus the source at least 5 times better than a simple biconvex lens.

Newport Corporation also offers LBP Series Laser Beam Profiler product, with a spectral range between 190 nm and 1600 nm. Together with a high magnification objective lens, it can provide the user with a powerful near field beam profiling capability.

### References:

<sup>1</sup>F. L. Pedrotti, S. J. and L. S. Pedrotti, "Introduction to Optics", 2nd Ed., Prentice Hall, Englewood Cliffs, New Jersey 07632, 1993, p. 366.

---

**Newport Corporation  
Worldwide Headquarters**

1791 Deere Avenue  
Irvine, CA 92606

(In U.S.): 800-222-6440  
Tel: 949-863-3144  
Fax: 949-253-1680

Internet: [sales@newport.com](mailto:sales@newport.com)



**Newport**

Experience | Solutions

Visit Newport Online at: [www.newport.com](http://www.newport.com)



Newport Corporation, Irvine, California, has been certified compliant with ISO 9001 by the British Standards Institution.

DS-09042